



Kramer Electronics Ltd.

USER MANUAL

MECHANICAL SWITCHING TOOLS

Models:

4x1S, 4x1V, 4x1VB, VP-201

**IMPORTANT: Before proceeding, please read paragraph entitled
"Unpacking and Contents"**

Table Of Contents

Section	Name	Page
1	Introduction	1
1.1	A word on video switchers	1
1.2	Factor affecting quality of results	1
2	Specifications	2
3	How do I get started?	3
4	Unpacking and contents	3
4.1	Optional accessories	3
5	Mechanical switchers	4
5.1	Getting to know your 4x1S switcher	4
5.2	Getting to know your 4x1V switcher	5
5.3	Getting to know your 4x1VB switcher	6
5.4	Getting to know your VP-201 switcher	7
6	Installation	8
6.1	Rack mounting	8
7	Connecting to video devices	8
8	Using the switchers	8
8.1	Controlling the switcher (4x1S, 4x1V, 4x1VB only)	8
8.2	VGA/XGA switching (VP-201 only)	8
8.3	Typical video switching	9
9	Taking care of your machine	10
10	Troubleshooting	10
10.1	Video signal	10
11	Limited warranty	11

List Of Illustrations

Figure		Page
1	4x1S side panel features	4
2	4x1V side panel features	5
3	4x1VB side panel features	6
4	VP-201 side panel features	7
5	VGA/XGA switching	9
6	Typical video switching	9

List Of Tables

Table		Page
1	4x1S side panel features	4
2	4x1V side panel features	5
3	4x1VB side panel features	6
4	VP-201 side panel features	7

1 INTRODUCTION

Congratulations on your purchase of this Kramer Electronics Switcher. Since 1981 Kramer has been dedicated to the development and manufacture of high quality video/audio equipment. The Kramer line has become an integral part of many of the best production and presentation facilities around the world. In recent years, Kramer has redesigned and upgraded most of the line, making the best even better. Kramer's line of professional video/audio electronics is one of the most versatile and complete available, and is a true leader in terms of quality, workmanship, price/performance ratio and innovation. In addition to the Kramer line of high quality switchers, such as the one you have just purchased, Kramer also offers a full line of high quality distribution amplifiers, processors, interfaces, controllers and computer-related products.

This manual includes configuration, operation and option information for the following products from the Kramer line of switching tools. These tools are similar in operation and features.

- **4x1S - 4:1 s-Video Switcher**
- **4x1V - 4:1 Video Switcher**
- **4x1VB - 4:1 Video Switcher**
- **VP-201 - 2:1 VGA Switcher**

1.1 A Word on Video Switchers

Switchers route one or more signals to one or more users. They vary in the number of inputs, programming capability, number of outputs, operating format (composite video, component, etc.) and switching method (i.e., whether they switch during the vertical interval or not, whether they are electronic, RS-232 or mechanically controlled). A video switcher usually switches between several sources (inputs) and one or more acceptors (outputs). A switcher that allows several inputs to be connected to several outputs simultaneously is called a Matrix Switcher. Switchers may be of the electronic or mechanical type, such as the ones described in this manual. Most matrices are of the active electronic type, with many crosspoints. Vertical Interval Switching, frequently used in video, ensures that the transition from one video source to another is smooth and without interference. The mechanical switchers described in this manual have full industrial specifications and are rack-mountable. Most of them offer a simple and economic solution for every video or VGA/XGA application. Due to very careful design, the video bandwidth is excellent.

1.2 Factors Affecting Quality of Results

There are many factors affecting the quality of results when signals are transmitted from a source to an acceptor:

- **Connection cables** - Low quality cables are susceptible to interference; they degrade signal quality due to poor matching and cause elevated noise levels. They should therefore be of the best quality.
- **Sockets and connectors of the sources and acceptors** - So often ignored, they should be of highest quality, since "Zero Ohm" connection resistance is the objective. Sockets and connectors also must match the required impedance (75ohm in video). Cheap, low quality connectors tend to rust, thus causing breaks in the signal path.
- **Amplifying circuitry** - Must have quality performance when the desired end result is high linearity, low distortion and low noise operation.
- **Distance between sources and acceptors** - Plays a major role in the result. For long distances (over 15 meters) between sources and acceptors, special measures should be taken in order to avoid cable losses. These include using higher quality cables or adding line amplifiers.
- **Interference from neighboring electrical appliances** - These can have an adverse effect on signal quality. Balanced audio lines are less prone to interference, but unbalanced audio should be installed far from any mains power cables, electric motors, transmitters, etc. even when the cables are shielded.

2 SPECIFICATIONS

	4x1S	4x1V	4xVB	VP-201
Configuration	4x1	4x1	4x1	2x1
Input Type	4 s-Video	4 video	4 video	2 VGA/XGA (RGB analog 0.7Vpp/75 Ohm, H, V sync TTL levels.
Input Connections	4P connectors	RCA connectors	BNC connectors	HD15F connector
Input Level	1Vpp/75ohm (Y), 0.3Vpp/75ohm (C)	1Vpp/75ohm	1Vpp/75ohm	1 VGA/XGA
Output Type	1 s-Video	1 composite or single component video	1 composite or single component video	VGA/XGA (RGB analog 0.7Vpp/75 Ohm, H, V sync TTL levels.
Output Connector	4P connector	RCA connector	BNC connector	HD15F connectors
Output Level	1Vpp/75ohm (Y) 0.3Vpp/75ohm (C)	1Vpp/75ohm	1Vpp/75ohm	RGB - 0.7Vpp / 75ohm, H & V syncs, TTL level
Switching system	Mechanical, Break-before-make	Mechanical, break-before-make	Mechanical, Break-before-make	Mechanical, Break-before-make
Bandwidth	>400 MHz (Y)	>400MHz	>400MHz	>320 MHz
Accessories	Mounting bracket	Mounting bracket	Mounting bracket	Mounting bracket
Dimensions (W, D, H)	12 x 7.5 x 2.5 (cm) (4.7" x 2.9" x 1")	12 x 7.5 x 2.5 (cm) (4.7" x 2.9" x 1")	12 x 7.5 x 2.5 (cm) (4.7" x 2.9" x 1")	12 x 7.5 x 2.5 (cm) (4.7" x 2.9" x 1")
Weight	0.25 kg. (0.55lbs.) Approx.	0.28kg. (0.62lbs.) Approx.	0.3 kg. (0.67 lbs.) Approx.	0.26kg. (0.58lbs.) Approx.

3 HOW DO I GET STARTED?

The fastest way to get started is to take your time and do everything right the first time. Taking 15 minutes to read the manual may save you a few hours later. You don't even have to read the whole manual. If a section doesn't apply to you, you don't have to spend your time reading it.

4 UNPACKING AND CONTENTS

The items contained in your Kramer accessory package are listed below. Please save the original box and packaging materials for possible future transportation and shipment of the accessory.

- **Switcher**
- **User Manual**
- **Kramer Concise Product Catalog**
- **Mounting Bracket**
- **4 Rubber Feet**

4.1 Optional Accessories

The following accessories, which are available from Kramer, can enhance implementation of your switcher. For information regarding cables and additional accessories, contact your Kramer dealer.

- **Rack Adapter** - Used to install smaller size machines in a standard 1 or 3 U rack. One or more machines may be installed on each adapter.
- **BNC "Y" Connector** - Used for looping purposes and splits the incoming signal to enable connection of an additional machine.
- **Termination Plug** - Used to terminate the line to 75ohm for proper matching.
- **A video or s-Video distribution amplifier** – such as the Kramer VM-3V, VM-50V, VM-10ARII, VM-20ARII (video), VM-3S, VM-50YC, VM-5YC, VM-10YC (s-Video) for distributing the output signals to several acceptors simultaneously.
- **A VGA/XGA distribution amplifier** – such as the Kramer VP-300, VP-400, VP-12xl – for distributing the selected VGA/XGA signal to several acceptors.
- **A line amplifier** – such as Kramer VM-9S, 104L (video), VM-9YC, 103YC (s-Video), VP-2xl, VP-22 (VGA/XGA) for transmitting the selected signals over long distances, minimizing cable losses.
- **VIDEO TESTER** - A new, unique, patented, indispensable tool for the video professional, the Video Tester is used to test a video path leading to/from an amplifier. By pressing only one touch switch it can trace missing signals, distinguish between good and jittery (VCR sourced) signals, and identify the presence of good signals. Whenever a video signal is missing- because of bad connections, cable breaks or faulty sources- the Video Tester is all you need.

5 MECHANICAL SWITCHERS

This section describes all the controls and connections of your switcher. Understanding all of the controls and connections helps you realize the full power of your switcher.

5.1 Getting to Know Your 4x1S switcher

The Kramer 4x1S is a high quality 4x1 mechanical switcher designed for s-Video (Y/C) signals using standard 4 pin S-video connectors. It accepts up to four inputs and allows the user to select any input to be routed to one output using buttons located on the side panel. High quality switching components are used to ensure minimal crosstalk and very high bandwidth. The entirely passive design of the 4x1S eliminates the need for a power supply. Unselected inputs are automatically terminated into a 75ohm resistor. The 4x1S is part of the Kramer Tools family of compact, high quality, cost effective solutions for a variety of applications.

Panel features of the 4x1S are described in Figure 1 and Table 1.

NOTE

For operation instructions refer to section 8.

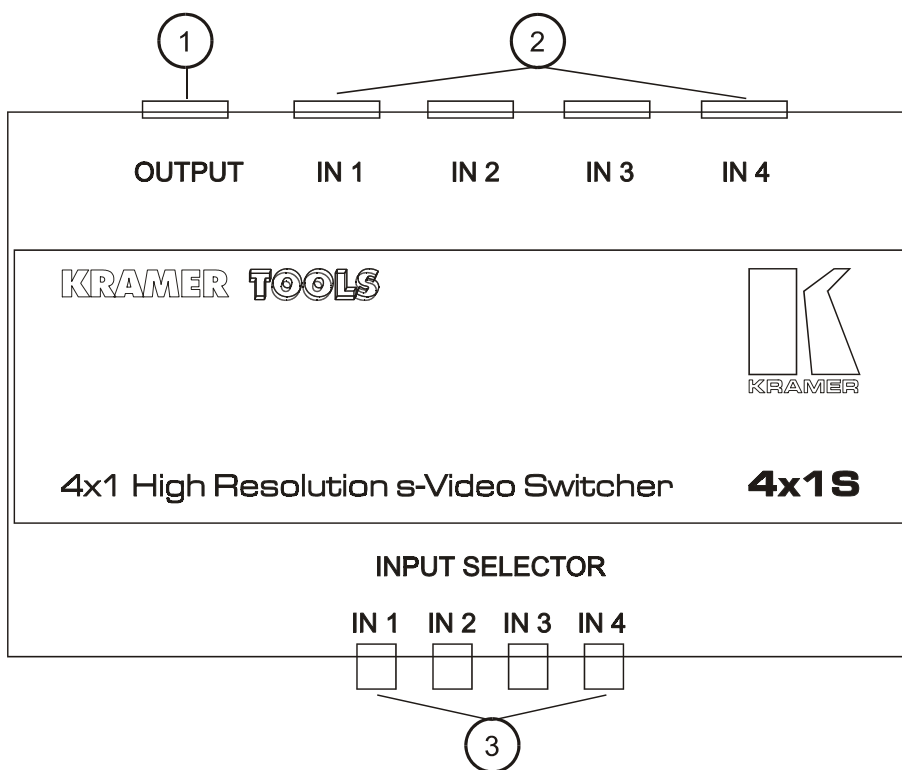

Figure 1: 4x1S Side Panel Features

Table 1: 4x1S Side Panel Features

No.	Feature	Function
1.	OUTPUT 4P connector	s-Video output.
2.	IN1-IN4 4P connectors	s-Video inputs.
3.	IN 1-IN 4 INPUT SELECTOR buttons	Select the desired input (IN1-IN4) to be switched to the output.

5.2 Getting to Know Your 4x1V switcher

The Kramer **4x1V** is a high quality 4x1 mechanical switcher designed for composite video signals using RCA connectors. It accepts up to four inputs and allows the user to select any input to be routed to one output using buttons located on the side panel. High quality switching components are used to ensure minimal crosstalk and very high bandwidth. The entirely passive design of the **4x1V** eliminates the need for a power supply. Unselected inputs are automatically terminated into a 75ohm resistor. The **4x1V** is part of the Kramer Tools family of compact, high quality, cost effective solutions for a variety of applications.

Panel features of the **4x1V** are described in Figure 2 and Table 2.

NOTE

For operation instructions refer to section 8.

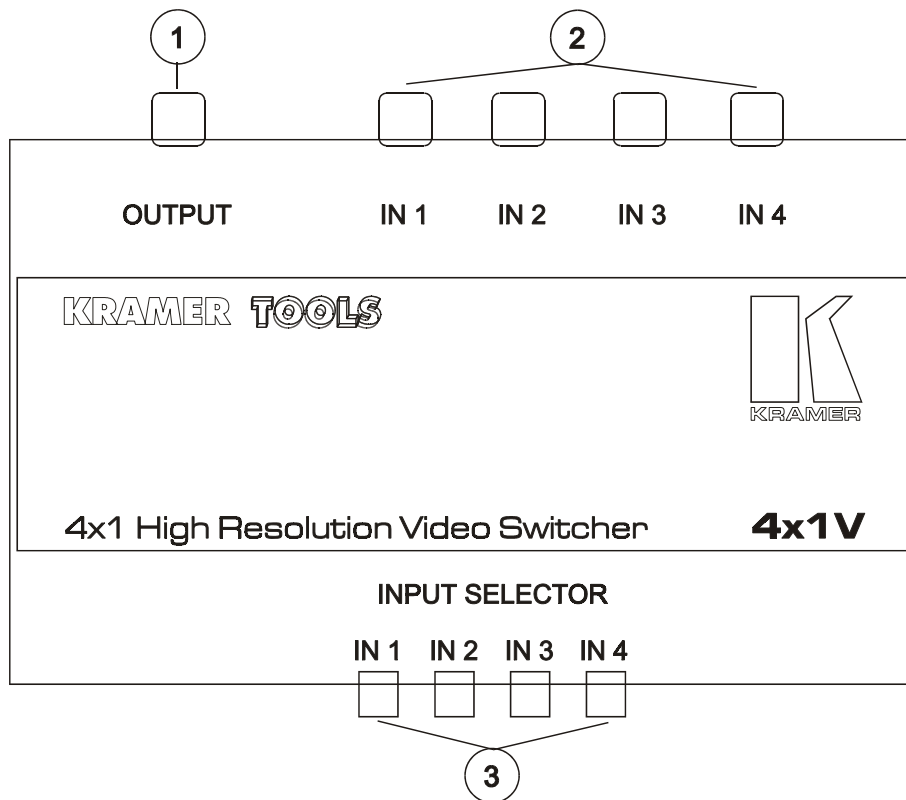

Figure 2: 4x1V Side Panel Features

Table 2: 4x1V Side Panel Features

No.	Feature	Function
1.	OUTPUT RCA connector	Composite/single component video output.
2.	IN1-IN4 RCA connectors	Composite/single component video inputs.
3.	IN 1-IN 4 INPUT SELECTOR buttons	Select the desired input (IN1-IN4) to be switched to the output.

5.3 Getting to Know Your 4x1VB switcher

The Kramer **4x1VB** is a high quality 4x1 mechanical switcher designed for composite video signals using BNC connectors. It accepts up to four inputs and allows the user to select any input to be routed to one output using buttons located on the side panel. High quality switching components are used to ensure minimal crosstalk and very high bandwidth. The entirely passive design of the **4x1VB** eliminates the need for a power supply. Unselected inputs are automatically terminated into a 75ohm resistor. The **4x1VB** is part of the Kramer Tools family of compact, high quality, cost effective solutions for a variety of applications.

Panel features of the **4x1VB** are described in Figure 3 and Table 3.

NOTE

For operation instructions refer to section 8.

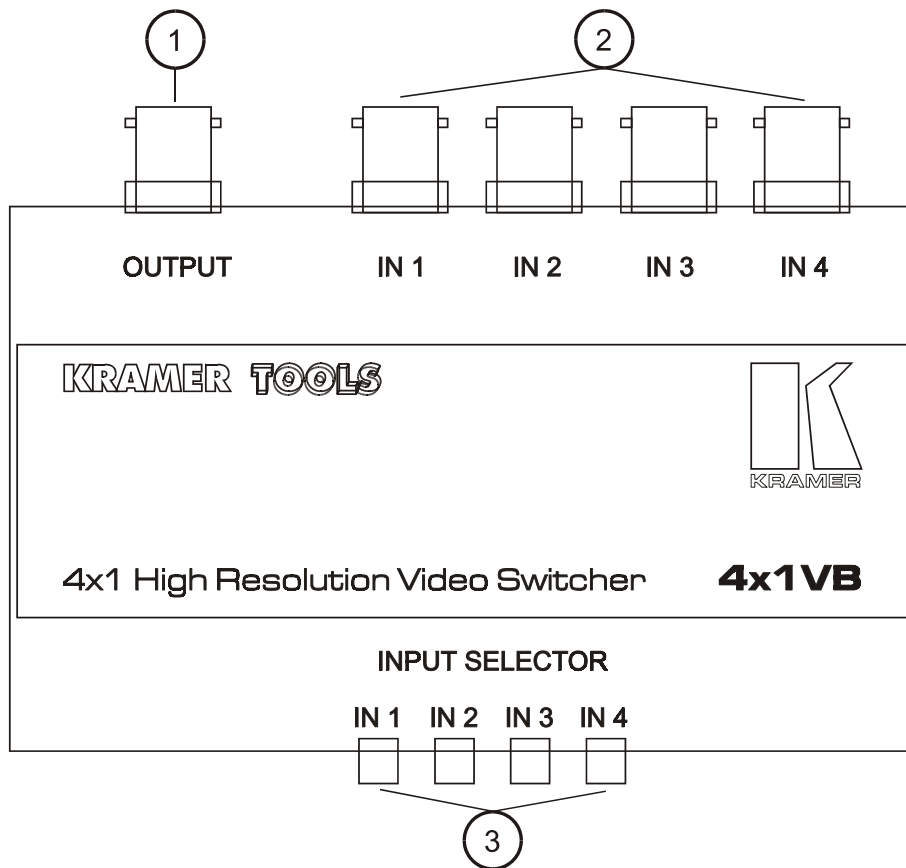

Figure 3: 4x1VB Side Panel Features

Table 3: 4x1VB Side Panel Features

No.	Feature	Function
1.	OUTPUT BNC connector	Composite/single component video output.
2.	IN1-IN4 BNC connectors	Composite/single component video inputs.
3.	IN 1-IN 4 INPUT SELECTOR buttons	Select the desired input (IN1-IN4) to be switched to the output.

5.4 Getting to Know Your VP-201 Switcher

The KRAMER **VP-201** is a full bandwidth, 2x1 High Resolution VGA/XGA Switcher designed for computer and workstations applications. The **VP-201** switches two VGA/Super-VGA/XGA graphics card outputs to one monitor or vice versa, with no discernible signal degradation. State-of-the-art PCB layout and careful transmission-line design make the KRAMER **VP-201** the first choice among mechanical Graphics Component Switchers. Signal bandwidth of 320MHz allows the **VP-201** to be used with the highest quality graphics workstations.

Panel features of the **VP-201** are described in Figure 4 and Table 4.

NOTE

For operation instructions refer to section 8.

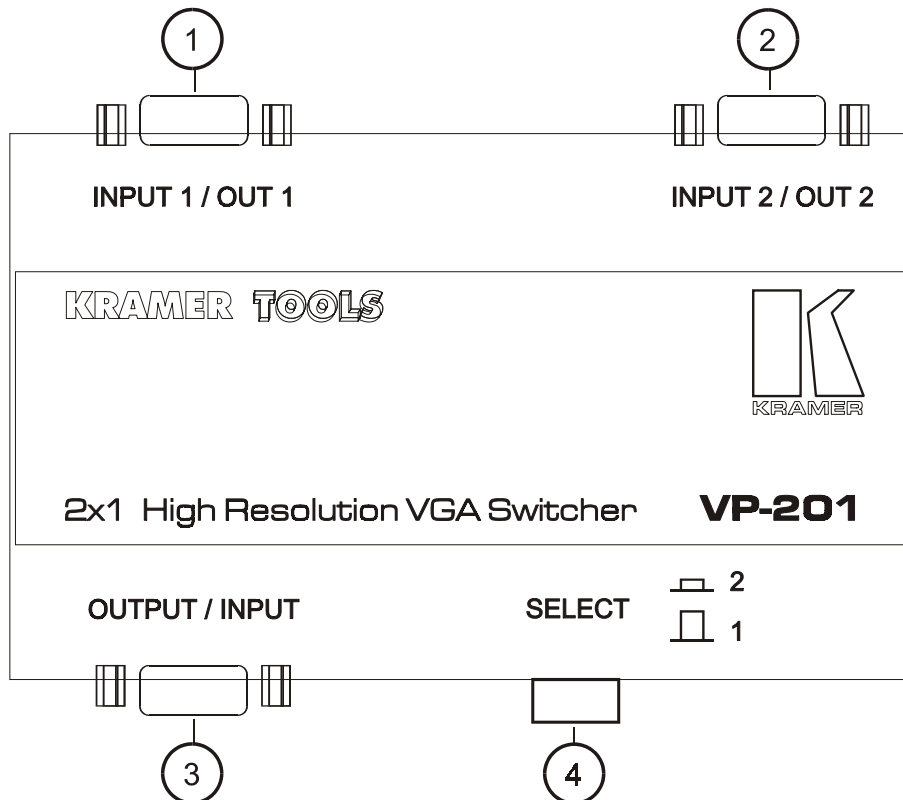

Figure 4: VP-201 Panel Features

Table 4: VP-201 VB Panel Features

No.	Feature	Function
1.	INPUT 1 HD15F connector	VGA/XGA signal input 1 (output 1.)
2.	INPUT 2 HD15F connector	VGA/XGA signal input 2 (output 2.)
3.	OUTPUT HD15F connector	VGA/XGA signal output (input.)
4.	SELECT – input selector button	Select the desired input (INPUT 1 when released, INPUT 2 when pressed.)

6 INSTALLATION

6.1 Rack Mounting

The Kramer Tools Switchers may be rack-mounted in a standard 19" (1 or 3U) EIA rack assembly, using a special Tools Adapter (1U or 3U model) and a mounting bracket (see section 4.1). They can also be table mounted using their rubber feet or the provided mounting brackets. These devices do not require any specific spacing above or below the unit for ventilation. To rack mount any of the machines, follow the installation instructions enclosed with the adaptor.

7 CONNECTING TO VIDEO DEVICES

Video sources and output devices (such as monitors or recorders) may be connected to the tools through the BNC connectors (4x1VB), through the RCA connectors (4x1V), through the 4P connectors (4x1S) located on the back of the unit or through the HD15F connectors (VP-201). The active inputs should be terminated by the connecting source. The output signal format should match that of the input signal format, (e.g.: If Composite video is input, then Composite video is output.) The signals supported by the various models are video, s-video and RGB signals.

8 USING THE SWITCHERS

8.1 Controlling the Switcher (4x1S, 4x1V, 4x1VB only)

- 1) Connect the switcher's input connectors to video / s-Video sources.
- 2) Connect the switcher 's output connector to an appropriate acceptor.
- 3) Press one of the switcher input selector buttons to select the input to be switched to the output.
- 4) Operate the sources and the acceptors.

8.2 VGA/XGA Switching (VP-201 only)

Figure 5 illustrates typical VGA/XGA switching configurations of the VP-201: In the "2 computers/1 monitor" configuration, one of two input signals from the computers is selected by the **SELECT** pushbutton (**INPUT 1** or **INPUT 2**) and switched to the monitor. In the "1 computer/2 monitors" configuration, the input computer signal is switched either to monitor 1 or monitor 2, depending on the **SELECT** pushbutton position (**OUT 1** or **OUT 2**).

Perform the following steps (as necessary):

- 1) Connect VGA/XGA source/s to the VGA/XGA input/s of the VP-201 as shown in Figure 5.
- 2) Connect acceptors to the outputs of the VP-201.
- 3) Select the desired input/output, to be switched, using the **SELECT** pushbutton.
- 4) Turn on the sources and acceptors.

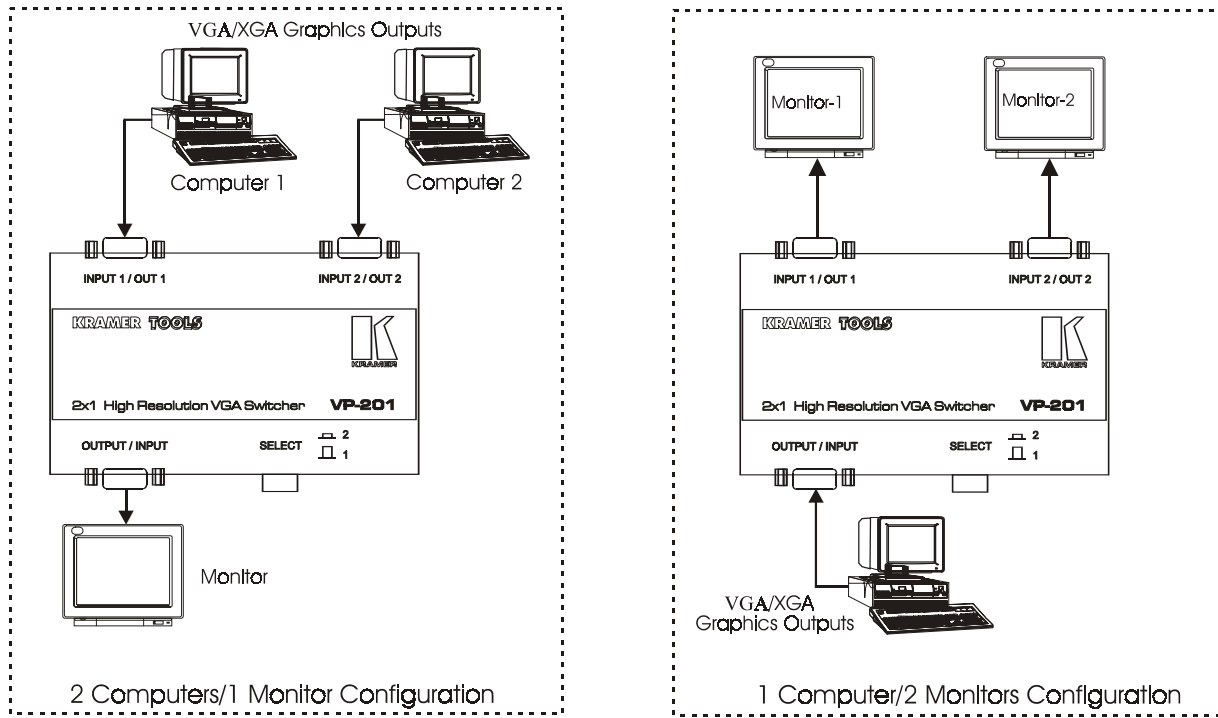

Figure 5: VGA/XGA Switching

8.3 Typical Video Switching

Figure 6 illustrates a typical video setup of the mechanical switchers: the incoming input signals from four sources (VCRs in this case) are switched to one output, connected to one acceptor. Control over the switched input is implemented by the input selectors located on the side panel of the machine (4x1S in this case). Perform the following steps (as necessary):

- 1) Connect the output of the video sources to the video inputs of the 4x1S.
- 2) Connect the output of the 4x1S to the input of a video acceptor.
- 3) Select the required video input to be switched, using front panel input selector pushbuttons.

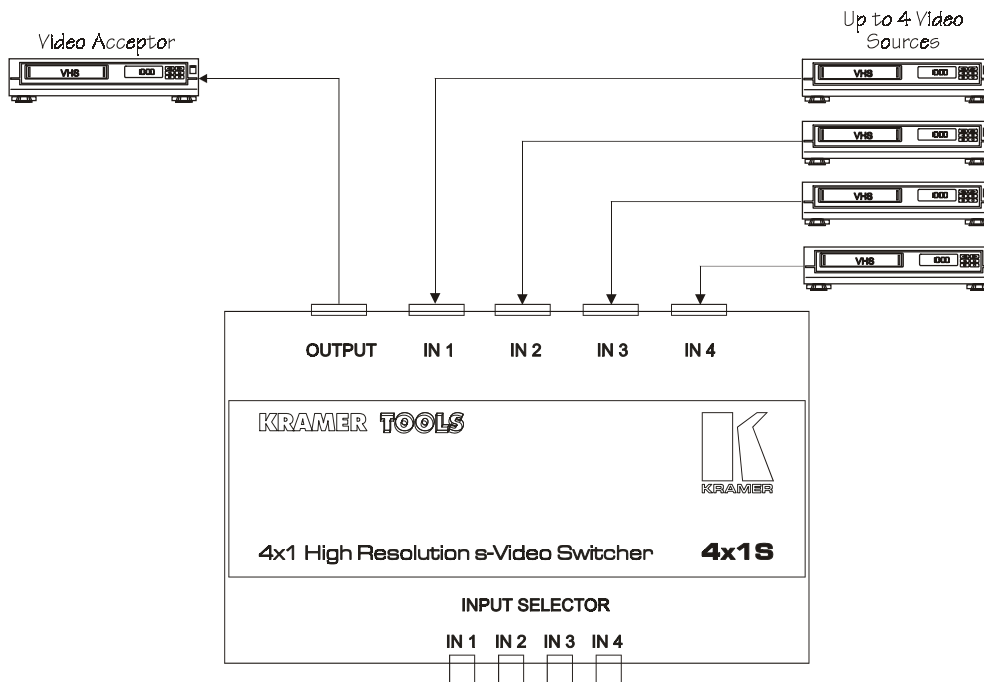

Figure 6: Typical Video Switching

9 TAKING CARE OF YOUR MACHINE

Do not locate your machine in an environment where it is susceptible to dust or moisture. Both of these may damage the electronics, and cause erratic operation or failure. Do not locate your machine where temperature and humidity may be excessive. Do not clean your machine with abrasives or strong cleaners. Doing so may remove or damage the finish, or may allow moisture to build up. Take care not to allow dust or particles to build up inside unused or open connectors.

10 TROUBLESHOOTING

10.1 Video Signal

Problem	Remedy
No video at the output device, regardless of input selected.	<ol style="list-style-type: none">1. Confirm that your sources and output device are powered on and connected properly.2. Confirm that any other switchers in the signal path have the proper input and/or output selected.3. Use a Video Tester to test the video path leading to/from your switcher (see section 4.1 " Video Tester")
Video level is too high or too dim.	<ol style="list-style-type: none">1. Verify that the video line is well matched through 75ohm impedance; otherwise it results in a video level that is too high or too dim.2. Confirm that the connecting cables are of high quality, properly built and terminated with 75ohm BNC connectors. Check level controls located on your source input device or output display or recorder.



LIMITED WARRANTY

Kramer Electronics (hereafter Kramer) warrants this product to be free from defects in material and workmanship under the following terms.

HOW LONG IS THE WARRANTY

Labor and parts are warranted for three years from the date of the first customer purchase.

WHO IS PROTECTED

Only the first purchase customer may enforce this warranty.

WHAT IS COVERED AND WHAT IS NOT COVERED

Except as below, this warranty covers all defects in material or workmanship in this product. The following are not covered by the warranty:

- 1) Any product which is not distributed by Kramer or which is not purchased from an authorized Kramer dealer. If you are uncertain as to whether a dealer is authorized, please contact Kramer at one of the agents listed in the web site www.kramerelectronics.com.
- 2) Any product, on which the serial number has been defaced, modified or removed.
- 3) Damage, deterioration or malfunction resulting from:
 - a) Accident, misuse, abuse, neglect, fire, water, lightning or other acts of nature.
 - b) Unauthorized product modification, or failure to follow instructions supplied with the product.
 - c) Repair or attempted repair by anyone not authorized by Kramer.
 - d) Any shipment of the product (claims must be presented to the carrier).
 - e) Removal or installation of the product.
 - f) Any other cause, which does not relate to a product defect.
 - g) Cartons, equipment enclosures, cables or accessories used in conjunction with the product.

WHAT WE WILL PAY FOR AND WHAT WE WILL NOT PAY FOR

We will pay labor and material expenses for covered items. We will not pay for the following:

- 1) Removal or installations charges.
- 2) Costs of initial technical adjustments (set-up), including adjustment of user controls or programming. These costs are the responsibility of the Kramer dealer from whom the product was purchased.
- 3) Shipping charges.

HOW YOU CAN GET WARRANTY SERVICE

- 1) To obtain service on you product, you must take or ship it prepaid to any authorized Kramer service center.
- 2) Whenever warranty service is required, the original dated invoice (or a copy) must be presented as proof of warranty coverage, and should be included in any shipment of the product. Please also include in any mailing a contact name, company, address, and a description of the problem(s).
- 3) For the name of the nearest Kramer authorized service center, consult your authorized dealer.

LIMITATION OF IMPLIED WARRANTIES

All implied warranties, including warranties of merchantability and fitness for a particular purpose, are limited in duration to the length of this warranty.

EXCLUSION OF DAMAGES

Kramer's liability for any defective products is limited to the repair or replacement of the product at our option. Kramer shall not be liable for:

- 1) Damage to other property caused by defects in this product, damages based upon inconvenience, loss of use of the product, loss of time, commercial loss; or:
- 2) Any other damages, whether incidental, consequential or otherwise. Some countries may not allow limitations on how long an implied warranty lasts and/or do not allow the exclusion or limitation of incidental or consequential damages, so the above limitations and exclusions may not apply to you.

This warranty gives you specific legal rights, and you may also have other rights, which vary from place to place.

NOTE: All products returned to Kramer for service must have prior approval. This may be obtained from your dealer.

NOTICE

This equipment has been tested to determine compliance with the requirements of:

- EN-50081:** "Electromagnetic compatibility (EMC); generic emission standard. Part 1: Residential, commercial and light industry".
- EN-50082:** "Electromagnetic compatibility (EMC) generic immunity standard. Part 1: Residential, commercial and light industry environment".
- CFR-47** FCC Rules and Regulations:
 - Part 15- "Radio frequency devices:
 - Subpart B- Unintentional radiators"

CAUTION

- Any user who makes changes or modifications to the unit without the express approval of the manufacturer will void user authority to operate the equipment.
- Please use recommended interconnect cables to connect the machine to controllers and other components.

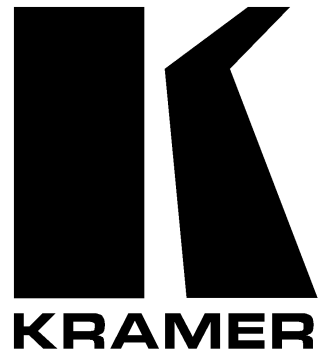

**The list of Kramer distributors appears on our web site:
www.kramerelectronics.com
From the web site it is also possible to e-mail factory headquarters.
We welcome your questions, comments and feedback.**